



HPPP2090015-00C	
Date	2024-12-10
CN	安装说明
EN	Instruction Sheet

1. 安全注意事项 (Safety precautions)

本说明书涉及产品为工业产品，并且均为开放型外壳设计。要求用户使用产品时，务必将产品安装于具有防尘、防潮以及免于电击/冲击等意外的控制柜内，并且需要设置保护措施以防止非维护人员不当操作或意外导致设备故障或损坏，造成不可避免的人员危险和财产损失。

The products in this manual are industrial products and are all open-type housing designs. It is essential to install these products within a control cabinet that is safeguarded against dust, moisture, and accidents such as electric shocks or physical impacts. Additionally, protective measures must be taken to prevent malfunctions or damage caused by improper operation or accidents involving non-maintenance personnel. Failure to do so may lead to serious risks to personnel safety and potential loss of property.

更详细的信息请参考 QX 系列硬件手册。

Please refer to the QX series hardware manual for more detailed information.

2. 适用型号 (Applicable model)

名称 (Name)	模块型号 (Model)	模块简要说明	Brief description
直流电源模块	HCQX-PD11-D4	直流24V输入电源模块	DC 24V input power module
交流电源模块	HCQX-PD11-A4	交流220V输入电源模块	AC 220V input power module

3. 通用电气及环境规格 (General electrical and environmental specifications)

3.1 通用电气规格 (General electrical specifications)

型号 (Model) ¹⁾	额定电压 ²⁾ / 功率	Rated voltage ²⁾ / power	输出电压 / 功率	Output voltage/power
HCQX-PD11-D4	DC24V (DC20.4~28.8V) / 200W MAX. ³⁾	DC24V (DC20.4~28.8V) / 200W MAX. ³⁾	DC24V/100W	DC24V/100W
HCQX-PD11-A4 ⁴⁾	AC220V (AC85~264V) 47~63Hz/120W	AC220V (AC85~264V) 47~63Hz/120W	DC24V/100W	DC24V/100W

*注：1. 所有型号均为安全特低电压输入产品。

2. 此处标识的额定功率为满载运行时的最大功率。

3. 在电源启动阶段，最大启动电流可以达到 8.8A，瞬时最大功率为 200W，为了保证电源正常启动，需要保证输入电源功率达到 200W，模块正常运行功率为 105W。

4. 消耗功率 1.2W，电源转换效率为 85%。

*Note: 1. All models are featured by the SELV input type.

2. The power rating indicated here is the maximum power under full-load operation.

3. During the power start-up stage, the maximum start-up current can reach 8.8A, and the instantaneous maximum power is 200W. In order to ensure the normal start-up of the power supply, it is necessary to ensure that the input power supply power reaches 200W and the normal operating power of the module is 105W.

4. Power consumption is 1.2W, and power conversion efficiency is 85%.

3.2 环境规格 (Environmental requirements)

项目	Item	规格	Specifications
海拔高度	Altitude	≤2000m	≤2000m
使用环境	Operating environment	控制柜内安装，开放式及室内使用	Installation within a control cabinet, open-type and indoor use
工作温度	Operating temperature	-10~55°C	-10~55°C
储存温度	Storage temperature	-40~75°C	-40~75°C
环境湿度	Ambient humidity	10~95% (无结露)	10~95%RH (non-condensation)
振动耐受	Vibration resistance	5~150Hz (X/Y/Z方向, 1g/3.5mm位移)	5~150Hz (X/Y/Z direction, 1g / 3.5mm displacement)
污染等级	Pollution degree	污染度2	Level 2
冷却方式	Cooling method	自然冷却	Natural air cooling
防护等级	IP rating	IP20	IP20
外壳材质	Enclosure material	阻燃材料	Self-extinguishable

*注：若设备未依制造商指定方式使用，设备所提供的保护可能会被减弱。

*Note: If the equipment is used in a manner not specified by the manufacturer, the protection provided by the equipment may be impaired.

4. 安装说明 (Installation instructions)

4.1 控制柜安装 (Installation within a control cabinet)

<p>CN 设备冷却方式为自然冷却或通过加装风扇进行冷却，请保证安装方向与柜壁垂直；请参考右侧示意图，在设备的周围留有足够的空间。并排安装时，建议横向两侧预留 20mm 以上间距。</p>		<p>EN Please install the product perpendicular to the wall and ensure a sufficient cooling effect via natural air or a cooling fan. Please leave enough clearance around the product as shown in the right figure. During a side-by-side installation, please leave a horizontal clearance of more than 20 mm on both sides.</p>
<p>垂直柜壁安装 Install the product perpendicular to the wall</p>		

4.2 电源模块拆装 (Power module mounting and dismounting)

<p>CN 安装电源模块时，将模块侧面导槽对准 Q 系列控制器导槽后，向内按压模块，听到“咔哒”声，模块成功安装于 DIN 导轨上（安装前保证双向联动卡扣处于紧锁状态，否则可能导致安装故障）；拆卸电源模块时，将卡扣向上拉动一定距离，听到“咔哒”声后，取下模块即可。</p>		<p>EN Before installation, check that the DIN rail mounting latch is in a locked state. During mounting, align the groove of the power module to that of the controller, and then press it inwards until a clear click is heard (which indicates the latch is momentarily opened and locked onto the rail). During dismounting, pull the latch upwards until a clear click is heard, and then directly remove the module.</p>
<p>紧锁状态 (Locked) 释放状态 (Unlocked)</p>		

4.3 线缆拆装 (Cable connecting and disconnecting)

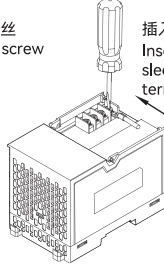
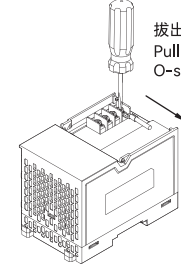
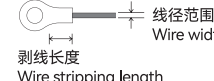
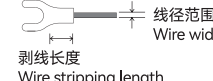
<p>CN 安装线缆时, 使用十字小螺丝刀将接线螺丝处拧松, 插入 U 型或套入 O 型端子后再拧紧螺丝, 轻拽线缆, 线缆不松动即成功完成配线; 反之即可取出线缆。</p>	<p>*使用M3螺丝 *Use a M3 screw</p> <p>插入U型或套入O型端子 Insert the U-shaped or sleeve the O-shaped terminal</p> 	<p>拔出U型或O型端子 Pull the U-shaped or O-shaped terminal</p> 		
<p>EN During connecting, use a small cross screwdriver to loosen the wiring screw, insert the U-shaped or sleeve the O-shaped terminal, and then tighten the screw. Gently tug the cable after pulling out the screwdriver. If the cable is secured firmly, then the connection is finished. The reverse is the procedure for unplugging the cable.</p>				
<p>线径范围: AWG (Wire width)</p> <p>22~14</p>	<p>剥线长度: mm (Wire stripping length)</p> <p>5</p>	<p>扭矩: N.m (Torsion force)</p> <p>0.5</p>	 <p>剥线长度 Wire stripping length</p> <p>线径范围 Wire width</p>	 <p>剥线长度 Wire stripping length</p> <p>线径范围 Wire width</p>

警告: 只能使用 75°C铜导线。

⚠ Warning: Use only a copper conductor that is 75° C.
Attention: Utilisez uniquement un conducteur en cuivre à 75° C.

4.4 接地 (Functional ground)

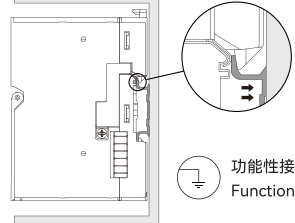
<p>CN CPU 单元背部的接地弹片与电源模块的侧边的接地弹片接触, 实现接地。</p>	<p>产品型号 (Product model)</p> <p>HCQX-PD11-D4 HCQX-PD11-A4</p>	 <p>功能性接地 (FE) Functional ground (FE)</p>
<p>EN The grounding spring on the back of the CPU unit contacts the grounding spring on the side of the power module to realize grounding.</p>		



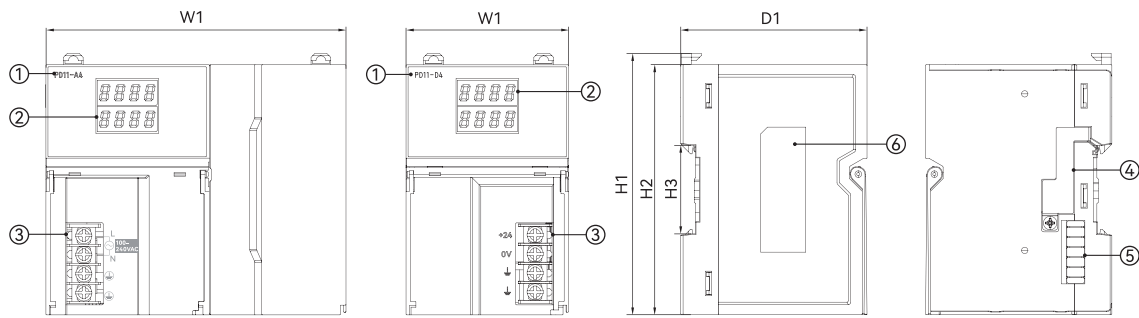



5. 接口和尺寸说明 (Interface and dimension description)



序号(No.)	名称	Name	功能	Function
1	产品型号	Product model	模块型号	Module model numbers
2	电源状态数码管	Module status indicator	显示电源状态	Display module and channel status
3	HCQX-PD11-D4: DC24V电源端子 HCQX-PD11-A4: AC220V电源端子	HCQX-PD11-D4: DC24V power terminal HCQX-PD11-A4: AC220V power terminal	HCQX-PD11-D4: DC24V供电接口 HCQX-PD11-A4: AC220V供电接口	HCQX-PD11-D4: DC24V power supply interface HCQX-PD11-A4: AC220V power supply interface
4	接地弹片	Grounding spring	功能性接地 (FE)	Functional grounding (FE)
5	CPU单元供电接口	CPU unit power supply interface	通过该接口连接CPU单元, 为CPU单元供电	The interface is used for connecting the CPU unit and supplying power to the CPU unit
6	标签	Label	显示模块型号、规格参数、内部序列号等基本信息	Display the basic information including module model, specification parameters, and internal serial number

型号 (Model)	外形尺寸 (Dimension) : mm					重量 (Weight) : g
	W1	H1	H2	H3	D1	
HCQX-PD11-D4	65.0	104.5	100.0	35.4	74.5	274 approx.
HCQX-PD11-A4	120.0	104.5	100.0	35.4	74.5	583 approx.

6. 数码管说明 (LED description)

项目 (Item)	状态*1 (Status)	说明	Description
	输出电压(单位) (Output voltage [unit])	使用 UPS 电源正常供电时, 显示供电电压	Display the supply voltage when the UPS power supply is used for normal power supply
	输出电流(单位) (Output current [unit])	使用 UPS 电源正常供电时, 显示供电电流	Display the supply current when the UPS power supply is used for normal power supply
	Err	电源报错	Power supply error
	LV	输入欠压或掉电报警	Input undervoltage or power failure alarm
	OC	过流报警	Overcurrent alarm
	OH	过热报警 (超 85°C)	Overheat alarm (over 85° C)
	LF	寿命报警 *2	Lifetime alarm *2

*注: 1. UPS 正常状态下数码管显示电流和电压, 异常状态下显示报错及报错代码。

2. 正常使用状态下, 工作寿命为 5 年, 出现错误后需更换电源, 否则该报错无法消除。

*Note: 1. Under normal UPS conditions, the LED display shows current and voltage, while under abnormal conditions, it displays error codes and error messages.

2. Under normal use, the working lifetime is 5 years. If an error occurs, the power supply needs to be replaced, otherwise the error cannot be eliminated.

7. 端子及配线说明 (Terminal and wiring description)

供电类型 (Power supply type)	型号 (Model)	HCQ3P-1400-D4	HCQ5P-1200-U4	HCQ5P-1300-U4	HCQ5P-1500-U4	HCQ5P-1600-U4	HCQ7P-1600-U4	HCQ9P-1700-U4
HCQX-PD11-D4	-	○	○	○	○	○	○	○
HCQX-PD11-A4	-	○	○	○	○	○	○	○

*注: ○: 代表支持该类型; -: 代表不支持该类型。

*Note: The symbol "○" indicates that the type is supported. The symbol "-" indicates that the type is not supported.

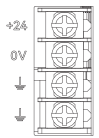
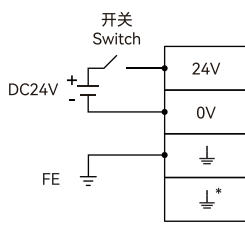
HCQX-PD11-D4 端子说明 (Terminal description)		接线 (Wiring)
24V		
0V		
⊥		
⊥*		
		FE 功能性接地 (Functional ground)

*注: 悬空, 预留。

*Note: Floating, reserved.

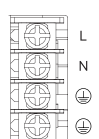
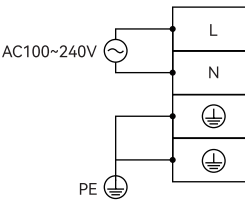
HCQX-PD11-A4 端子说明 (Terminal description)		接线 (Wiring)
L		
N		
⊥		
⊥		
		PE 保护接地 (Protective ground)