



禾川科技官方网站

07060201-0765-001
Date 2024-12-26
CN 安装说明
EN Installation Sheet

1. 安全注意事项 (Safety precautions)

本说明书涉及产品为工业产品，并且均为开放型外壳设计。要求用户使用时，务必将产品安装于具有防尘、防潮以及免于电击 / 冲击等意外的控制柜内，并且需要设置保护措施以防止非维护人员不当操作或意外导致设备故障或损坏，造成不可避免的人员风险和财产损失。

The products in this manual are industrial products and are all open-type housing designs. It is essential to install these products within a control cabinet that is safeguarded against dust, moisture, and accidents such as electric shocks or physical impacts. Additionally, protective measures must be taken to prevent malfunctions or damage caused by improper operation or accidents involving non-maintenance personnel. Failure to do so may lead to serious risks to personnel safety and potential loss of property.

更详细的信息请参考 QP 系列硬件手册。
Please refer to the QP series hardware manual for more detailed information.

⚠ 电池 Battery	QP 系列 CPU 内置磁吸式电池组件型号为 HCQP-BAT，需从禾川采购更换，弹片式电池型号为 CR2032 (3.2V, 10mA)，可自行选购符合 UL 认证且规格参数合适的电池进行更换。
	For the QP series CPU built-in magnetic battery, its model number is HCQP-BAT, and it needs to be purchased from HCFA for replacement. For the spring-contact battery, its model number is CR2032 (3.2V, 10mA), and it can be replaced by purchasing UL-certified batteries with appropriate specifications.
	Pour la batterie magnétique intégrée à l'unité centrale de la série QP, son numéro de modèle est HCQP-BAT, et elle doit être achetée auprès de la HCFA pour être remplacée. Pour la pile à contact à ressort, son numéro de modèle est CR2032 (3.2V, 10mA), et elle peut être remplacée en achetant des piles certifiées UL avec les spécifications appropriées.

2. 命名规则 (Model identification)

HC Q5 P - 1 5 0 0 - U 4 - XXXX
1 2 3 4 5 6 7 8 9 10

1	产品名称 (Product name)	4	操作系统 (Operating system)	8	电源类型 (Power supply type)
HC	禾川 (Hechuan Technology)	1	Linux	U	UPS电源 (UPS power supply)
2	产品系列 (Product series)	5	内部编号 (Internal number)	9	迭代版本 (Iteration version)
Q5	基本智能型机械控制器 (Basic intelligent machine controller)	2/3/5/6	预留 (Reserved)	4	第4代 (The 4th generation)
3	系列型号 (Series type)	6	控制软件模块 (Control software module)	10	软件/固件定制代码 (Customized software/firmware code)
空 (N/A)	标准型 (Standard type)	0	CODESYS	X	0~9/A~Z/空 (N/A)
P	增强型 (Enhanced type)	7	控制软件 (Control software)		
		0	标准软件 (Standard software)		

3. 适用型号 (Applicable model)

名称 (Name)	型号 (Model)	适配的电源型号 ¹ (Applicable power model)	适配的 IO 型号 ² (Applicable IO model)	简要说明 (Brief description)
CPU单元 CPU unit	HCQ5P-1200-U4	HCQX-PD11-D4	HCQX-EC01-D4 HCQX-EC02-D4 HCQX-EC03-D4 HCQX-ES06-D4 HCQX-ID16-D4 HCQX-OD16-D4	Intel Celeron处理器、硬盘64G、内存2G、掉电保持区6M、16点输入16点输出、16轴EtherCAT总线、2路以太网口、1路EtherCAT口、RS485*2、RS232*1、USB-A*1、USB-C*1、SD卡*1 Intel Celeron processor, 64G hard disk, 2G RAM, 6M persistent data memory, 16-channel input and 16-channel output, 16-axis EtherCAT bus, 2-channel Ethernet port, 1-channel EtherCAT port, RS485*2, RS232*1, USB-A*1, USB-C*1, SD card*1 支持协议 (Supported protocols): Modbus RTU, Modbus TCP, EtherCAT, EtherNet/IP, OPC UA
	HCQ5P-1300-U4		HCQX-OD16-D4-PNP HCQX-MD16-D4 HCQX-MD16-D4-PNP HCQX-ID32-D4 HCQX-OD32-D4	Intel Celeron处理器、硬盘64G、内存2G、掉电保持区6M、16点输入16点输出、32轴EtherCAT总线、8轴脉冲、2路以太网口、1路EtherCAT口、RS485*2、RS232*1、USB-A*1、USB-C*1、SD卡*1 Intel Celeron processor, 64G hard disk, 2G RAM, 6M persistent data memory, 16-channel input and 16-channel output, 32-axis EtherCAT bus, 8-axis pulse, 2-channel Ethernet port, 1-channel EtherCAT port, RS485*2, RS232*1, USB-A*1, USB-C*1, SD card*1 支持协议 (Supported protocols): Modbus RTU, Modbus TCP, EtherCAT, EtherNet/IP, OPC UA
	HCQ5P-1500-U4		HCQX-OD32-D4-PNP HCQX-MD32-D4 HCQX-MD32-D4-PNP HCQX-AD04-D4 HCQX-DA04-D4	Intel Celeron处理器、硬盘64G、内存2G、掉电保持区6M、16点输入16点输出、32+32轴EtherCAT总线、8轴脉冲、3路以太网口、1路EtherCAT口、RS485*2、RS232*1、CAN*1、USB-A*1、USB-C*1、SD卡*1 Intel Celeron processor, 64G hard disk, 2G RAM, 6M persistent data memory, 16-channel input and 16-channel output, 32+32-axis EtherCAT bus, 8-axis pulse, 3-channel Ethernet port, 1-channel EtherCAT port, RS485*2, RS232*1, CAN*1, USB-A*1, USB-C*1, SD card*1 支持协议 (Supported protocols): Modbus RTU, Modbus TCP, EtherCAT, CANopen, EtherNet/IP, OPC UA
	HCQ5P-1600-U4		HCQX-TS04-D4 HCQX-RS02-D4 HCQX-RS02-D4-M HCQX-OC08-D4	Intel Celeron处理器、8G EMMC、2G内存、掉电保持区6M、16点输入16点输出、64+64轴EtherCAT总线、8轴脉冲、3路以太网口、1路EtherCAT口、RS485*2、RS232*1、CAN*1、USB-A*1、USB-C*1、SD卡*1 Intel Celeron processor, 8G EMMC, 2G RAM, 6M persistent data memory, 16-channel input and 16-channel output, 64+64-axis EtherCAT bus, 8-axis pulse, 3-channel Ethernet port, 1-channel EtherCAT port, RS485*2, RS232*1, CAN*1, USB-A*1, USB-C*1, SD card*1 支持协议 (Supported protocols): Modbus RTU, Modbus TCP, EtherCAT, CANopen, EtherNet/IP, OPC UA

*注: 1. 在电源启动阶段，最大启动电流可以达到 8.8A，瞬时最大功率为 200W，为了保证电源正常启动，需要保证输入电源功率达到 200W，模块正常运行功率为 105W，输出功率为 100W。
2. CPU 单元右侧可挂载模块数量以实际功率计算。

*Note: 1. During the power supply start-up phase, the maximum starting current can reach 8.8 A, while the instantaneous maximum power is 200 W. To ensure the power supply starts up normally, the input power must be at least 200 W. The module's normal operating power is 105 W, and the output power is 100 W.
2. The number of modules that can be mounted on the right side of the CPU unit is calculated based on the actual power.

4. 通用电气及环境规格 (General electrical and environmental specifications)

4.1 通用电气规格 (Electrical specifications)

型号 (Model) ¹	额定电压 / 功率 (Rated voltage/power) ²	输出电压 / 功率 (Output voltage/power)	数字量输入 / 输出类型 (Digital input/output type)
HCQ5P-1200-U4	DC24V (DC 20.4V~28.8V)/35W	DC12V/16W	数字量输入 (Digital input): DC24V, 6.81mA/Ch 芯片输出 (Digital output): DC24V, 500mA/Ch, 4A/16Ch*3 负载类型: 阻性/电磁负载 (Resistive/Pilot duty)
HCQ5P-1300-U4			
HCQ5P-1500-U4			
HCQ5P-1600-U4			

*注: 1. 所有型号仅能在由有限功率电源 (LPS) 提供的安全特低电压 (SELV) 下运行。
2. 此处标识的额定功率为满载运行时的最大功率。
3. 考虑温升影响，降额使用。

*Note: 1. All models can only operate under the safety extra low voltage (SELV) provided by a limited power source (LPS).
2. The power rating indicated here is the maximum power under full-load operation.
3. Consider the effect of temperature rise and derate during using.

4.2 环境规格 (Environmental requirements)			
项目	Item	规格	Specifications
海拔高度	Altitude	≤2000m	≤2000m
使用环境	Operating environment	控制柜内安装, 开放式及室内使用	Installation within a control cabinet, open-type and indoor use
工作温度	Operating temperature	-10~55°C	-10~55°C
储存温度	Storage temperature	-40~75°C	-40~75°C
环境湿度	Ambient humidity	10~95%RH (无结露)	10~95%RH (non-condensing)
振动耐受	Vibration resistance	5~150Hz (X/Y/Z方向, 1g/3.5mm位移)	5~150Hz (X/Y/Z direction, 1g/3.5mm displacement)
污染等级	Pollution degree	污染度2	Level 2
冷却方式	Cooling method	风冷	Cooling fan
防护等级	IP rating	IP20	IP20
外壳材质	Enclosure material	阻燃材料	Self-extinguishable

*注: 若设备未依制造商指定方式使用, 设备所提供的保护可能会被减弱。

*Note: If the equipment is used in a manner not specified by the manufacturer, the protection provided by the equipment may be impaired.

5. 安装说明 (Installation instructions)

5.1 控制柜安装 (Installation within a control cabinet)

CN 设备冷却方式为通过加装风扇进行冷却, 请保证安装方向与柜壁垂直; 请参考右侧示意图, 在设备的周围留有足够的空间。并排安装时, 建议横向两侧预留20mm以上间距。

EN Please install the product perpendicular to the wall and ensure a sufficient cooling effect via a fan. Please leave enough clearance around the product as shown in the right figure. During a side-by-side installation, please leave a horizontal clearance of more than 20 mm on both sides.

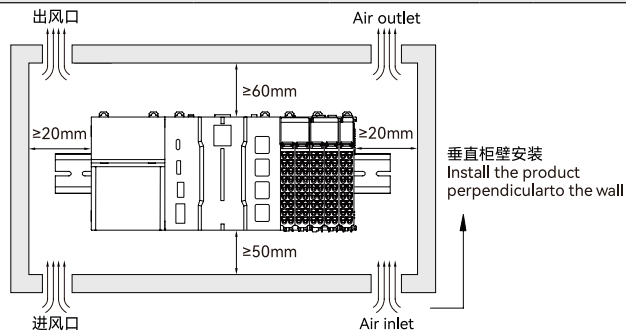

5.2 导轨拆装 (DIN rail mounting and dismounting)

CN 安装控制器时, 将控制器后双向联动卡扣上部紧扣在 DIN 导轨上, 并用力按压控制器下部, 听到“咔哒”声, 控制器即成功安装于 DIN 导轨上 (安装前应保证双向联动卡扣处于紧锁状态, 否则可能导致安装故障); 拆卸控制器时 (如有电源模块需先拆卸电源模块), 将双向联动卡扣向上拉动一定距离, 听到“咔哒”声后, 取下控制器即可。

EN Before installation, check that the DIN rail mounting latch is in a locked state. During mounting, position the upper part of the mounting latch of the controller on the DIN rail, and then press the controller against the DIN rail until a clear click is heard (which indicates the latch is momentarily opened and locked onto the rail). During dismounting (if there is a power module, please dismount it first), pull the latch upwards until a clear click is heard (which indicates the latch is unlocked), and then directly remove the controller.

将双向联动卡扣上部紧扣在DIN导轨上, 并向导轨侧按压控制器

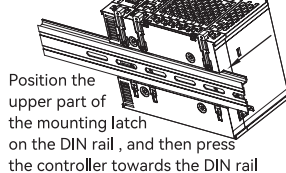

①向上拉动双向联动卡扣并向导轨侧拉动 DIN 导轨 mounting latch
②取下控制器 Detach the controller

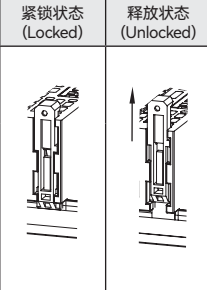
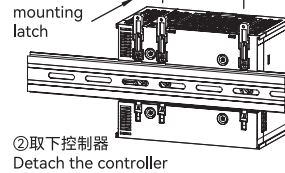

5.3 电源模块拆装 (Power module mounting and dismounting)

CN 安装电源模块时, 将电源模块上部滑轨对准控制器滑轨, 向内推动, 当电源模块与控制柜底部平齐时即完成组装; 拆卸电源模块时, 向外推动电源模块, 电源模块脱离控制器后, 将其取下。

EN During mounting, align the groove of the power module to that of the controller, and then press it inwards until their lower parts click together. During dismounting, pull the power module outwards until it is detached from the controller, and then directly remove the module.

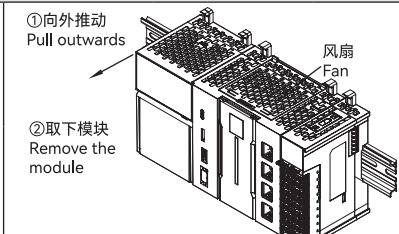
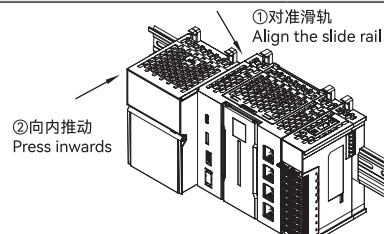

警告: 控制器内置风扇, 用户不可自行拆卸, 遇到风扇故障请联系禾川售后进行更换。
Warning: The controller is equipped with a built-in fan, which cannot be detached by users. If a fan failure is encountered, please contact HCFA after-sales service for replacement.

5.4 磁吸式电池拆装 (Magnetic battery mounting and dismounting) *

CN 磁吸式电池组件仅支持半成品更换安装。捏紧磁吸式电池槽两侧后向外拔出电池组件, 即可完成电池拆卸; 将电池组件向内插入控制器中, 即可完成电池安装。

EN Magnetic battery assembly only supports semi-finished product replacement and installation. During dismounting, pinch both sides of the magnetic battery compartment and then pull it outwards. During mounting, insert the battery compartment into the controller directly.

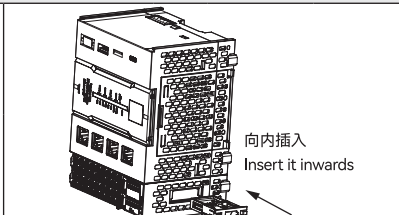
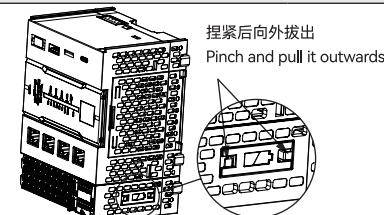

5.5 弹片接触式电池拆装 (Spring-contact battery mounting and dismounting) *

CN 弹片接触式电池组件支持电池独立更换。捏紧弹片接触式电池槽两侧后向外拔出电池组件。在电池正反两面施力, 使其顺时针旋转, 然后沿箭头方向取出电池, 即可完成电池拆卸。将电池斜放入电池槽中, 在电池正反两面施力, 使其逆时针旋转至电池卡入电池槽, 然后将电池组件插入控制器中, 即可完成电池安装。

EN Spring-contact battery assembly supports independent battery replacement. During dismounting, pinch the spring-contact type battery compartment on both sides and then pull it outwards. Apply force to the front and back of the battery to rotate it clockwise, and then remove the battery along the direction of the arrow. During mounting, place the battery diagonally into the battery compartment, apply force on the front and back of the battery to rotate it counterclockwise until the battery clips into the battery compartment, then insert the battery compartment into the controller.

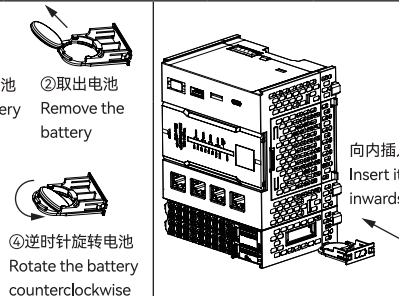
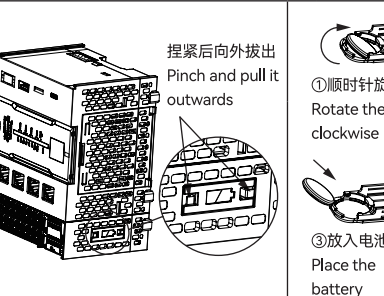

*注: 不同版本的 Q5P 可能支持不同类型的电池安装方式, 具体请参考实物结构。

*Note: Different versions of Q5P may support different types of battery installation, please refer to the physical structure.

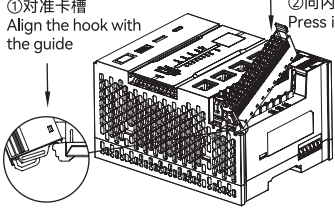
5.6 可拆卸端子拆装 (Removable terminal block mounting and dismounting)			
CN	安装可拆卸端子排时，将端子排底部对准模块底部凹槽并紧扣，上部对齐模块并向内施压，当听到“咔哒”声即完成组装；拆卸端子排时，向下摁压端子排顶部卡扣，使其脱离模块本体并以底部卡扣呈圆弧状斜向下施力，将端子排取下。	①对准卡槽 Align the hook with the guide	②向内按压 Press inwards
EN	During mounting, align the mounting hook at the bottom of the terminal block to the guide of the module and press inwards on the terminal block until a clear click is heard (which indicates the terminal block has been locked to the module). During dismounting, press the lock lever on the terminal block and then detach it from the module.		①按压端子顶部弹簧片 Press the lock lever
			②取下端子 Detach the terminal block

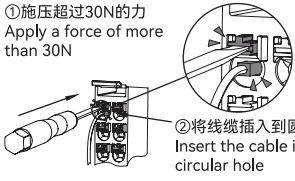
⚠ 5.7 线缆拆装 1 (Cable connecting and disconnecting I)			
CN	安装线缆时，将一字螺丝刀垂直插入 18Pin IO 端子压块内，施加超过 30N 的力，此时圆孔打开，将准备好的线缆插入到圆孔中，拔出一字螺丝刀，轻拽线缆，线缆不松动即成功完成配线，反之即可取出线缆。端子规格及配线示意图如右图所示。	①施压超过 30N 的力 Apply a force of more than 30N	②将线缆插入到圆孔中 Insert the cable into the circular hole
EN	During connecting, insert the flat-blade screwdriver into the 18Pin IO terminal unlocking tab with a force of more than 30N. Then insert a cable into the circular hole. Gently tug the cable after pulling out the screwdriver. If the cable is secured firmly, then the connection is finished. The reverse is the procedure for unplugging the cable. The terminal specifications and wiring diagram are shown in the right figure.		①施压超过 30N 的力 Apply a force of more than 30N
			②将线缆拔出 Unplug the cable

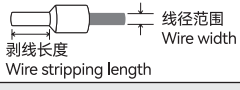
控制器端子 (Terminal)	线径范围: AWG (Wire width)	剥线长度: mm (Wire stripping length)	按压力: N (Pressure)	
18Pin IO端子 (18Pin IO terminal)	24~17	8~10	30	剥线长度 Wire stripping length

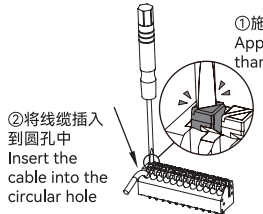
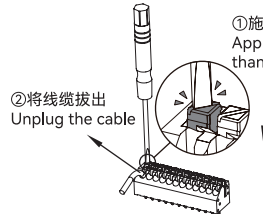
⚠ 5.8 线缆拆装 2 (Cable connecting and disconnecting II)			
CN	安装线缆时，将一字螺丝刀垂直插入 12Pin 通讯端子压块内，施加超过 16N 的力，此时圆孔打开，将准备好的线缆插入到圆孔中，拔出一字螺丝刀，轻拽线缆，线缆不松动即成功完成配线；反之即可取出线缆。	①施压超过 16N 的力 Apply a force of more than 16N	②将线缆拔出 Unplug the cable
EN	During connecting, insert the flat-blade screwdriver into the 12Pin communication terminals unlocking tab with a force of more than 16N. Then insert a cable into the circular hole. Gently tug the cable after pulling out the screwdriver. If the cable is secured firmly, then the connection is finished. The reverse is the procedure for unplugging the cable. The terminal specifications and wiring diagram are shown in the right figure.		

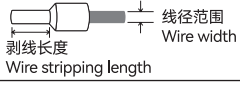
控制器端子 (Terminal)	线径范围: AWG (Wire width)	剥线长度: mm (Wire stripping length)	按压力: N (Pressure)	
12Pin通讯端子 (12Pin communication terminal)	28~16	8~9	16	剥线长度 Wire stripping length

警告：只能使用 75°C 铜导线。
Warning: Use only a copper conductor that is 75°C.
Attention: Utilisez uniquement un conducteur en cuivre à 75°C.

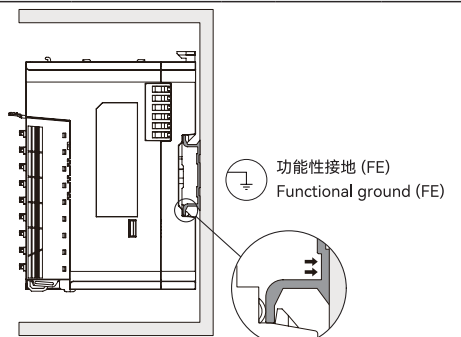
5.9 接地 (Functional ground)		产品型号 (Product model)	
CN	QP 控制器通过背部金属弹片接地，示意图如右图所示。	HCQ5P-1200-U4 HCQ5P-1300-U4 HCQ5P-1500-U4 HCQ5P-1600-U4	
EN	The QP controller is grounded through a metal spring on the back side, as shown in the diagram on the right.		功能性接地 (FE) Functional ground (FE)

6. 接口和尺寸说明 (Interface and dimension description)

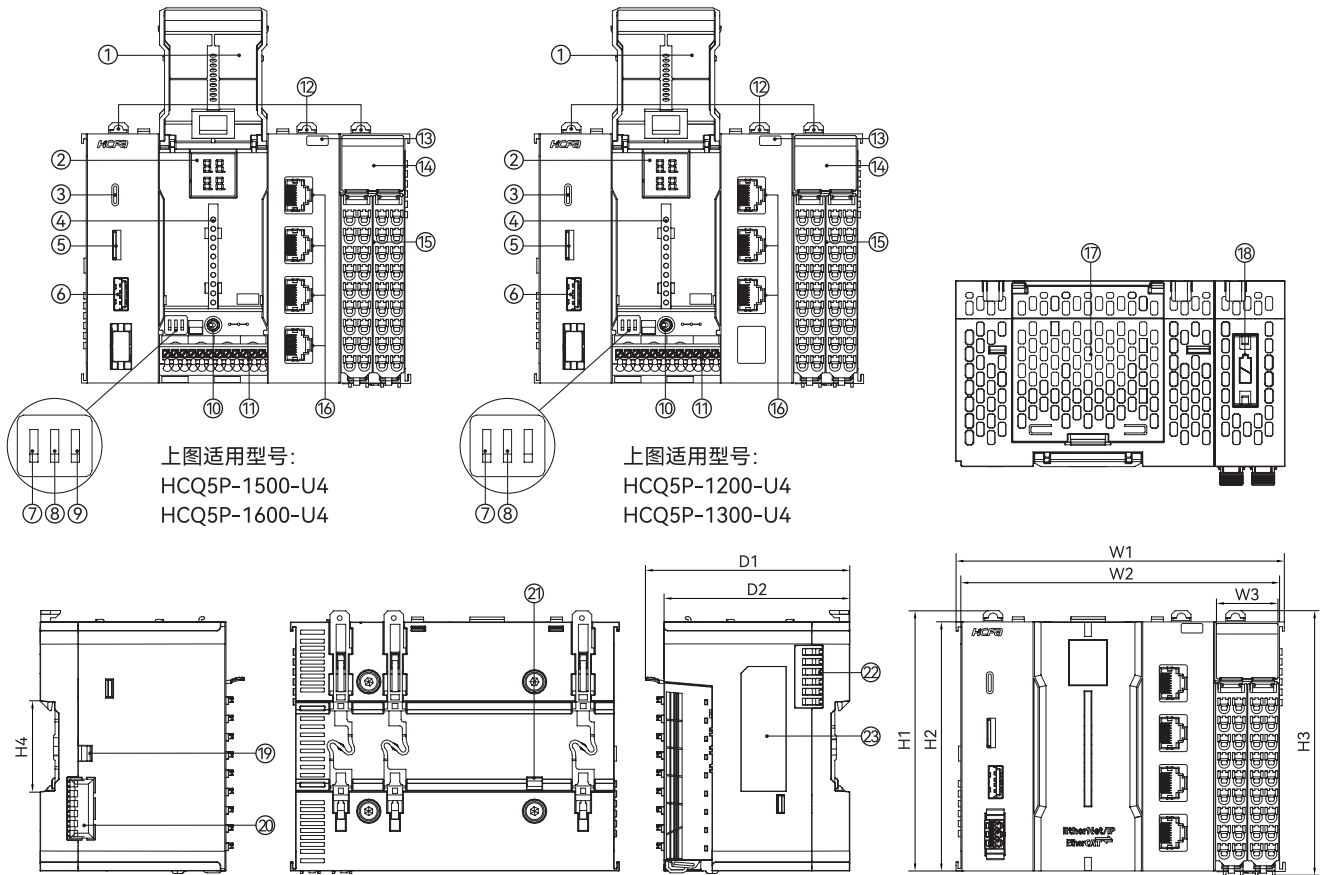

序号 (No.)	名称	Name	功能	Function	
1	前翻盖	Front flip cover	保护内部指示灯与端子	Protects the indicators and terminals	
2	数码管	LED	显示系统运行状态和报错代码	Displays system operation status and error code	
3	Type-C接口	Type-C interface	支持高清数字显示接口标准, 支持DC5V/1A供电	Supports high-definition digital display interface standard, supports DC5V/1A power supply	
4	指示灯	Indicator	显示控制器运行, SD卡/U盘连接与通讯接口状态	Displays the status of controller operation, SD card/U disk connection, and communication interface	
5	SD卡槽	SD card slot	支持Micro SD卡插入, 用于数据存储, 程序导入导出	Supports Micro SD card insertion for data storage, program import, and export	
6	USB-A接口	USB-A interface	支持U盘导入/导出程序与文件读写, 支持DC5V/1A供电	Supports U disk program import/export and file reading/writing, supports DC5V/1A power supply	
7	COM1终端电阻开关	COM1 termination resistor switch	向上拨动为开启终端电阻, 向下拨动为关闭终端电阻, 出厂默认关闭状态	Toggle up to turn on the terminating resistor, toggle down to turn off the terminating resistor, off by factory default	
8	COM2终端电阻开关	COM2 termination resistor switch			
9	CAN终端电阻开关*	CAN termination resistor switch*			
10	STOP/RUN/FN 拨码开关	STOP/RUN/FN dial switch	功能拨码, 向左为控制器停止状态, 中间为运行状态, 向右拨至FN并停留3s为恢复Port1/port2/port4 IP默认值	DIP switch. Toggle to the left to put the controller in the STOP state. Toggle to the center to put it in the RUN state. Toggle to the right to put it to the FN state for 3s to restore the IP addresses of Port1/port2/port4 to the default value	
11	12Pin通讯端子*	12Pin communication terminal*	RS485/RS232/CAN通讯接口	RS485/232/CAN communication interface	
12	双向联动卡扣	DIN rail mounting latch	固定模块在DIN导轨上	Mounts the module onto a DIN rail	
13	产品型号	Product model	显示CPU单元型号	Displays CPU unit model	
14	模块状态指示灯	Module status indicator	显示模块与通道状态	Displays module and channel status	
15	18Pin IO端子	左侧 输入	18Pin IO terminal	Left input	16通道数字量输入
		右侧 输出	Right output	16通道数字量输出	16-channel digital output
16	RJ45 通讯接口	RJ45 communication interface	Port1 EtherNet	千兆以太网口, 支持Modbus TCP、OPC UA、EtherNet/IP Scanner和Adapter Port1 IP: 192.168.188.100	Gigabit Ethernet port, supports Modbus TCP, OPC UA, EtherNet/IP Scanner and Adapter Port1 IP: 192.168.188.100
			Port2 EtherNet	千兆以太网口, 支持Modbus TCP、OPC UA、EtherNet/IP Scanner和Adapter Port2 IP: 192.168.88.100	Gigabit Ethernet port, supports Modbus TCP, OPC UA, EtherNet/IP Scanner and Adapter Port2 IP: 192.168.88.100
			Port3 EtherCAT	千兆以太网口, 支持EtherCAT主站	Fast Ethernet port, supports EtherCAT master
			Port4 EtherNet/EtherCAT*	千兆以太网口, 支持Modbus TCP、OPC UA、EtherNet/IP Scanner和Adapter; 支持EtherCAT主站 port4 IP: 192.168.8.100	Gigabit Ethernet port, supports Modbus TCP, OPC UA, EtherNet/IP Scanner and Adapter, and EtherCAT master port4 IP: 192.168.8.100
17	风扇	Fan	散热	Heat dissipation	
18	RTC电池	RTC battery	维持部分系统参数	Maintains part of the system parameters	
19	金属弹片 (悬空)	Metal spring (float)	无功能, 预留接口	No function, reserved interface	
20	电源模块连接接口	Power module connection interface	主机供电接口, 通过该接口连接电源模块, 为CPU单元供电	The interface for the power supply of the host, by which the power supply module is connected to supply power to the CPU unit	
21	接地弹片	Grounding spring	功能性接地 (FE)	Functional grounding (FE)	
22	扩展模块通讯接口	Expansion terminal communication interface	主机和IO模块通讯及供电接口, 不支持热插拔	The interface for the communication and power supply of the host and IO modules, does not support hot-swapping	
23	标签	Label	显示CPU单元型号, 规格参数、内部序列号等基本信息	Displays the basic information including CPU unit model, specification parameters, and internal serial number	

*注: HCQ5P-1200-U4、HCQ5P-1300-U4 不支持 CAN 和 Port4。

* Note: The CAN and Port4 are unavailable for the HCQ5P-1200-U4 and HCQ5P-1300-U4.

型号 (Model)	外形尺寸 (Dimension) : mm									重量 (Weight) : g
	W1	W2	W3	H1	H2	H3	H4	D1	D2	
HCQ5P-1200-U4	132.2	127.9	24.4	104.5	100.0	105.5	35.4	82.0	74.5	722 approx.
HCQ5P-1300-U4										
HCQ5P-1500-U4										
HCQ5P-1600-U4										

7. 指示灯说明 (Indicator description)

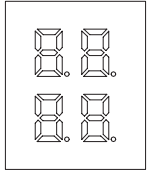

数码管 (LED)	状态	Status	说明	Description
	开机	Boot	开机中	Booting up
	Run	Run	正常运行	Run
	Stop	Stop	停止	Stop
	报错	Error	错误代码	Error code

丝印 (Screen printing)	指示灯含义 (Indicator meaning)	颜色 (Color)	状态	Status	说明	Description
SYS	系统状态 (System status)	红色 Red		其他 Other	发生故障	Error
				闪烁 Blinking	正常运行	Run
SD_BUSY	SD 卡 / U 盘 (SD card/U disk)	红色 Red		熄灭 Not lit	SD 卡 / U 盘安全卸载或全部拔出	Uninstall or unplug the SD card /USB flash drive successfully
				常亮 Lit	成功加载 SD 卡 / U 盘	Load the SD card /USB flash drive successfully
CAN *	CANOpen 通讯 (CANOpen communication)	-	-	-	-	-
COM1	RS485 通讯 (RS485 communication)	TX 绿色 Green		熄灭 Not lit	未发送数据	No data is being sent to other devices
COM2				闪烁 Blinking	正在发送数据给其他设备	Data is being sent to other devices
COM3	RS232 通讯 (RS232 communication)	RX 红色 Red		熄灭 Not lit	未接收数据	No data is being received from other devices
				闪烁 Blinking	正在接收其他设备发送的数据	Data is being received from other devices
QBUS L/A	QBUS 通讯 (QBUS communication)	黄色 Yellow		熄灭 Not lit	通讯断开 / 故障	Communication is abnormal or disconnected
				闪烁 Blinking	通讯正常	Communication is normal
IN N (0~7,10~17)	输入 (Input)	绿色 Green		熄灭 Not lit	输入通道 N 未检测到输入信号	The input channel N has not detected input signals
				常亮 Lit	输入通道 N 检测到输入信号	The input channel N has detected input signals
OUT N (0~7,10~17)	输出 (Output)	绿色 Green		熄灭 Not lit	输出通道 N 无信号输出	There is no output signal in this channel
				常亮 Lit	输出通道 N 有信号输出	There are output signals in this channel
EtherNet EtherCAT	LINK 物理连接 (Physical connection)	绿色 Green		熄灭 Not lit	未建立物理连接	Physical connection has not been established
				常亮 Lit	已建立物理连接	Physical connection has been established
EtherNet/EtherCAT	ACT 数据交互 (Data exchange)	黄色 Yellow		熄灭 Not lit	未收发数据	No data is being sent or received
				闪烁 Blinking	正在收发数据	Data is being sent or received

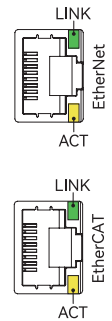
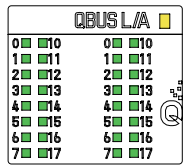
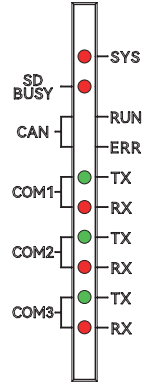

*注: 后续支持。

*Note: It will be supported subsequently.

8. 端子及配线说明 (Terminal and wiring description)

型号 (Model)	高速输入输出 (High-speed input and output)	RS485 (COM1,COM2)	RS232 (COM3)	CAN
HCQ5P-1200-U4	x	✓	✓	x
HCQ5P-1300-U4	✓	✓	✓	x
HCQ5P-1500-U4	✓	✓	✓	✓
HCQ5P-1600-U4	✓	✓	✓	✓

18Pin IO 端子说明 (18Pin IO terminal description)		IN		OUT		类型 (Type)	通用IO接线 (General IO wiring)	高速IO接线 (High-speed IO wiring) ¹⁾
0		10	I0	I10	Q0	Q10	开关 Switch 漏型输入 NPN Input	编码器 Encoder 屏蔽层 Shield 0V DC24V DC24V
1		11	I1	I11	Q1	Q11		
2		12	I2	I12	Q2	Q12		
3		13	I3	I13	Q3	Q13	开关 Switch 源型输入 PNP Input	编码器 Encoder 屏蔽层 Shield 0V DC24V DC24V
4		14	I4	I14	Q4	Q14		
5		15	I5	I15	Q5	Q15		
6		16	I6	I16	Q6	Q16	负载 Load DC24V 漏型输出 NPN Output	脉冲PLS_out 方向PLS_dir DC24V
7		17	I7	I17	Q7	Q17		
8	18	SS ²⁾	SS ²⁾	COM ²⁾	COM ²⁾			

*注: 1.HCQ5P-1200-U4 不支持高速输入输出。

2. 输入公共端 SS 内部导通, 输出公共端 COM 内部导通。

*Note: 1.HCQ5P-1200-U4 does not support high-speed input and output.

2.The input terminals SS are internally conductive, and so are the output terminals COM.

12Pin通讯端子说明 (12Pin communication terminal description)

定义 (Definition)	A1	B1	SG	A2	B2	SG	TX	RX	SG	H	L	SG
接口 (Interface)	COM1			COM2			COM3			CAN		

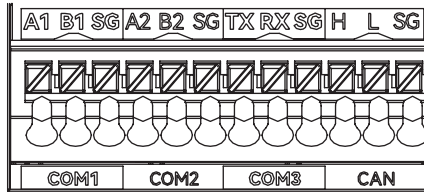

COM1/COM2 RS485接线 (RS485 Wiring)

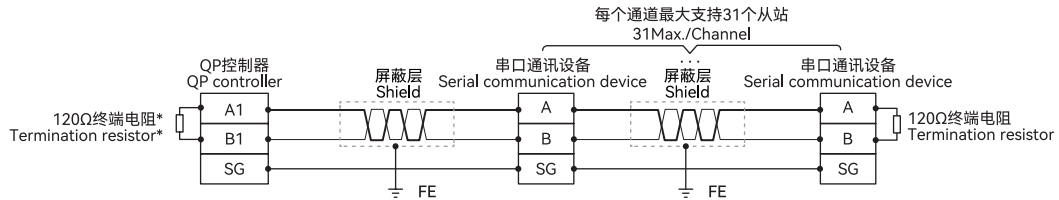

COM3 RS232接线 (RS232 Wiring)

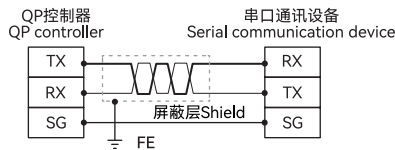

CAN CANOpen接线 (CANOpen Wiring)

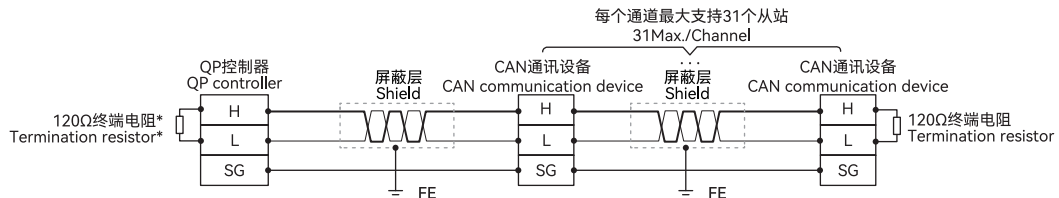

*注: 内置终端电阻, 通过终端电阻拨码开关启用。

*Note: Built-in terminating resistor, which is enabled by the terminating resistor DIP switch.