

1	2	3	4	5	6	7	8
修改记录 REVISIONS							
A	版本 REV	标记 MARK	事项 DESCRIPTION	日期 DATE	核准 APPROVED		
	V1.0		建立图纸	20230705	夏鑫岩		

备注：建议为线缆留出70mm的走线空间，  
如图示虚线框示意。

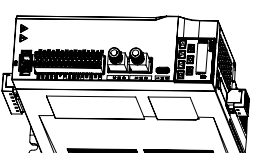
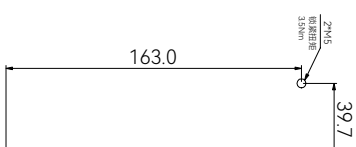
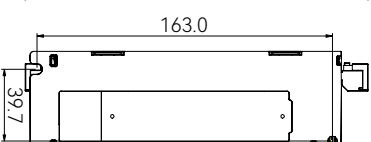
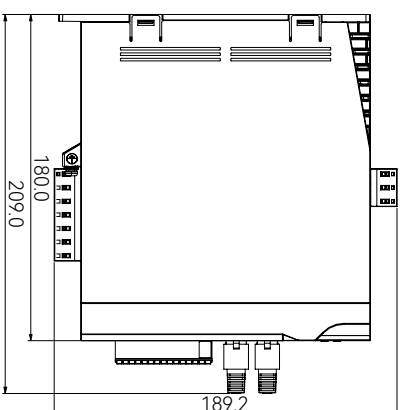
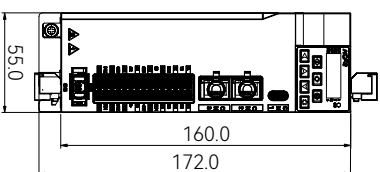
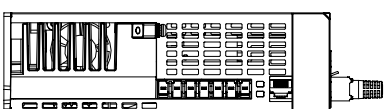
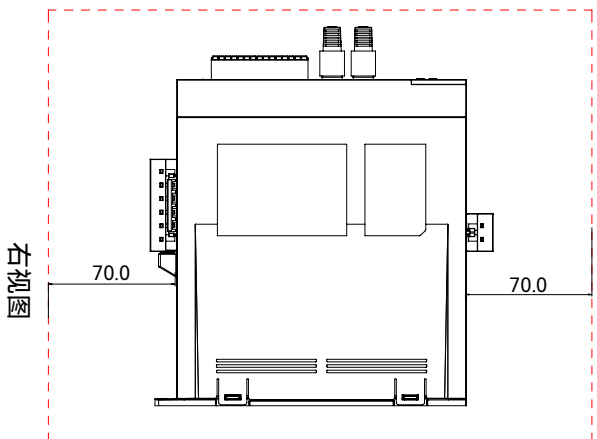

备注信息：  
此图用于示意HDV-E610 (380V-1.5KW和  
380V-0.75KW)的外形尺寸，具体外管和详细的安装说明  
请参考样品手册。

材质 MATERIAL	1.01kg	比例 SCALE	1:1	日期 DATE	20230705	零件名称 PART NAME	HDV-E610-1.5KW-外形尺寸图
质量 QUALITY	1.01kg	设计 DESIGNED BY	刘成硕	页码 SHEET	第1页共1页	零件编码 PART CODE	
		制图 DRAWN BY	刘成硕	校对 CHECKED BY	夏鑫岩	批准 APPROVED BY	夏鑫岩
		设计 DESIGNED BY	刘成硕	校 CHECKED BY	夏鑫岩	准 APPROVED BY	夏鑫岩

GB/T 1804-2000-v	未注尺寸公差按照国标执行	ZHEJIANG 禾川科技股份有限公司 HECHUAN TECHNOLOGY CO.,LTD.	
		禾川图纸，非禾川标识不得转让，流转和留档作他用。	