

电机性能规格
MOTOR PERFORMANCE SPECIFICATION

法兰 FLANGE	130
额定功率(W) RATED POWER	1000
额定电压(V) RATED VOLTAGE	380
每相感应电压常数(mV/(r/min)) INDUCED VOLTAGE CONSTANT PER PHASE	*A
额定电流(A) RATED CURRENT	3
瞬时最大电流(A) INSTANTANEOUS MAXIMUM CURRENT	9
额定转矩(N.m) RATED TORQUE	4.77
瞬时最大转矩(N.m) INSTANTANEOUS MAXIMUM TORQUE	12
相q轴电感(mH) Q PHASE-AXIS INDUCTANCE	*A
相d轴电感(mH) D PHASE-AXIS INDUCTANCE	*A
线圈电阻(Ω) COIL RESISTANCE	*A
线圈电感(mH) COIL INDUCTANCE	*A
额定转速(rpm) RATED ROTATION SPEED	2000
最高转速(rpm) MAXIMUM ROTATION SPEED	3000
转子转动惯量无刹车(10^{-4} kg.m ²) ROTOR MOMENT OF INERTIA WITHOUT BRAKE	6.18
转子转动惯量带刹车(10^{-4} kg.m ²) ROTOR MOMENT OF INERTIA WITH BRAKE	7.4
转子极对数P NUMBER OF ROTOR POLES P	5
定子槽数S NUMBER OF STATOR SLOTS S	12
编码器类型 ENCODER RESOLUTION	23bit
电机绝缘等级 MOTOR INSULATION LEVEL	F
电机防护等级 MOTOR PROTECTION LEVEL	IP67

轴端面局部:
Shaft-end dimension:

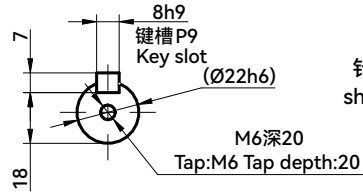

信号线插头:
Encoder connector:

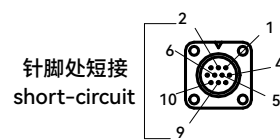

带刹车动力线插头:
Power connector with brake:

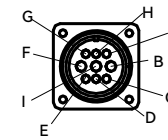

无刹车动力线插头:
Power connector without break:

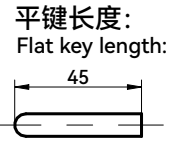
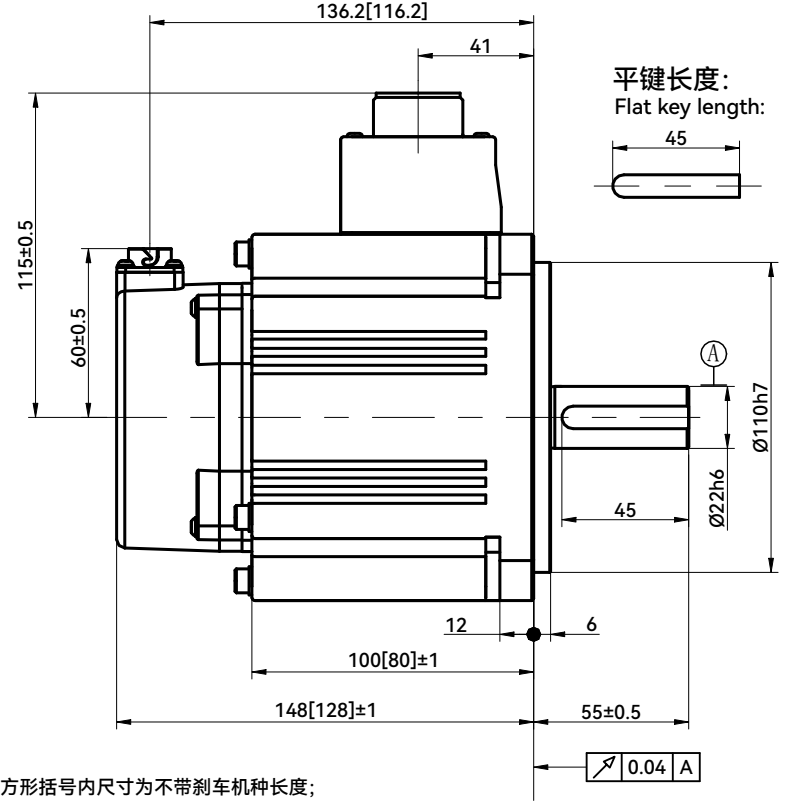
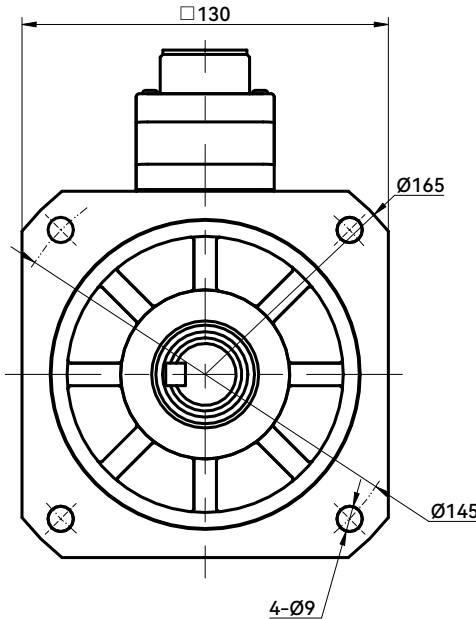
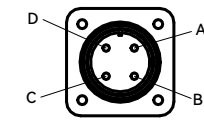

信号线连接
Encoder connector

端子号码 TERMINAL NUMBER	信号名 SIGNAL NAME	备注 NOTE
1	VCC	
2	GND	
3	-	
4	BATT	
5	+DO	
6	-DO	
7	-	
8	-	
9	BAT-	
10	FG	

带刹车动力线连接
Power connector with brake

端子号码 TERMINAL NUMBER	信号名 SIGNAL NAME	备注 NOTE
A	-	
B	W	
C	-	
D	FG	
E	FG	
F	U	
G	BRK1	
H	BRK1	
I	V	

无刹车动力线连接
Power connector without brake

端子号码 TERMINAL NUMBER	信号名 SIGNAL NAME	备注 NOTE
A	U	
B	V	
C	W	
D	FG	

注: 1. 方括号内尺寸为不带刹车机种长度;
2. *A处详细参数请咨询我司技术人员。
Note: 1. Dimensions in brackets are for non-brake type length;
2. Please consult our technical personnel for detailed parameters at location *A.

客户回签
Customer signature

						HCFB 浙江禾川科技股份有限公司 Zhejiang Hechuan Technology Co.,Ltd			
						1000W伺服电机 1000W Servo motor			
						X6MM100A-N(B)4LD			
标记 MARK	处数 NUMBER OF REVISED	分区 SECTION	更改文件号 REVISED DOCUMENT NUMBER	签名 SIGNATURE	年月日 DATE	阶段标记 STAGE MARKER		重量 WEIGHT	比例 SCALE
设计 DESIGN	1	01	2023.7.26	官宏					
审核 VERIFY	1		2023.7.26	徐宏福					
工艺 CRAFT				批准 APPROVE	2023.7.26	共 张 第 张 PAGE ,ALTOGETHER PAGE			