

修改记录
REVISIONS

版本 REV	标记 MARK	事项 DESCRIPTION	日期 DATE	核准 APPROVED
V1.3				

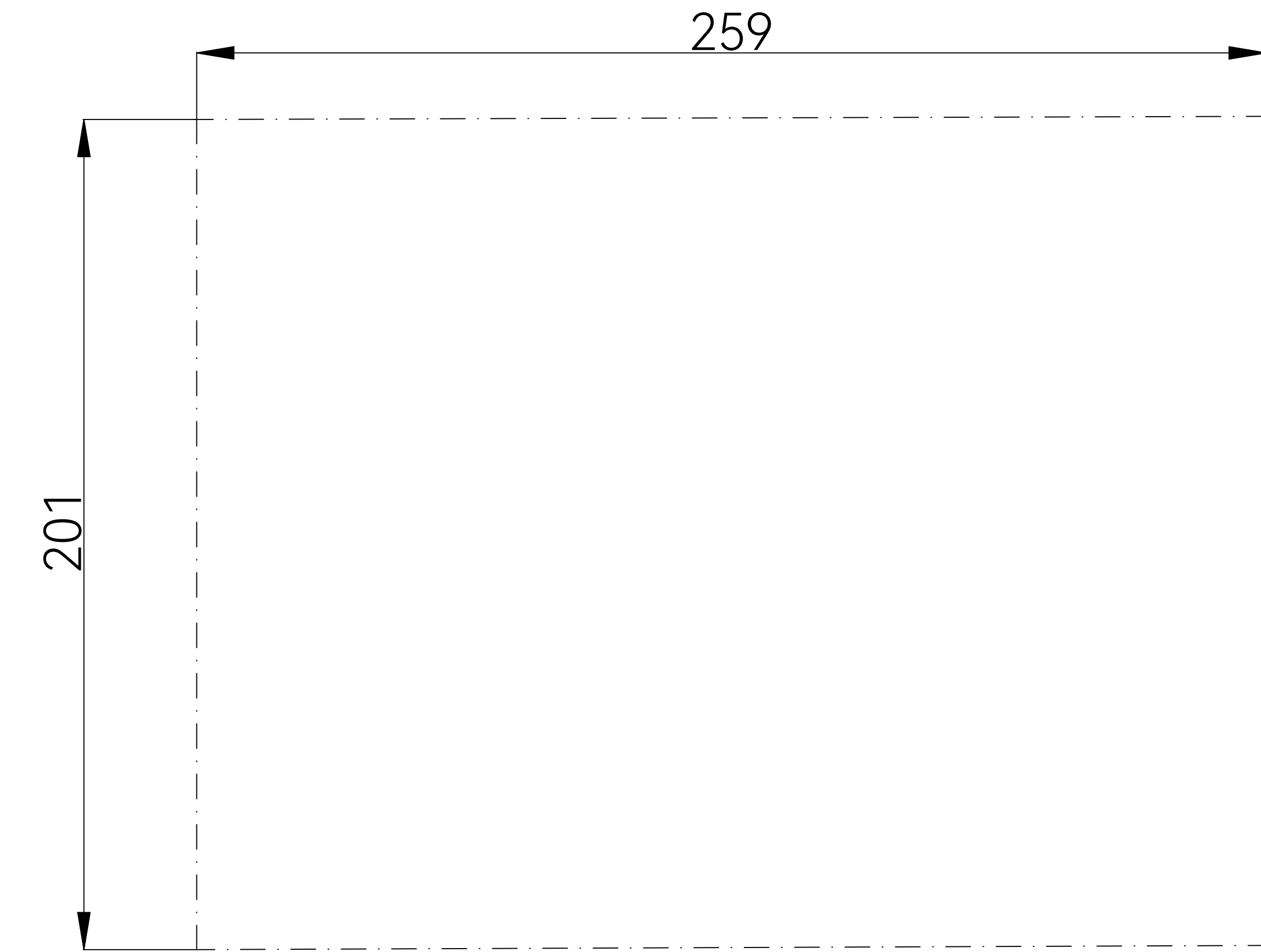

注：开孔尺寸201*259

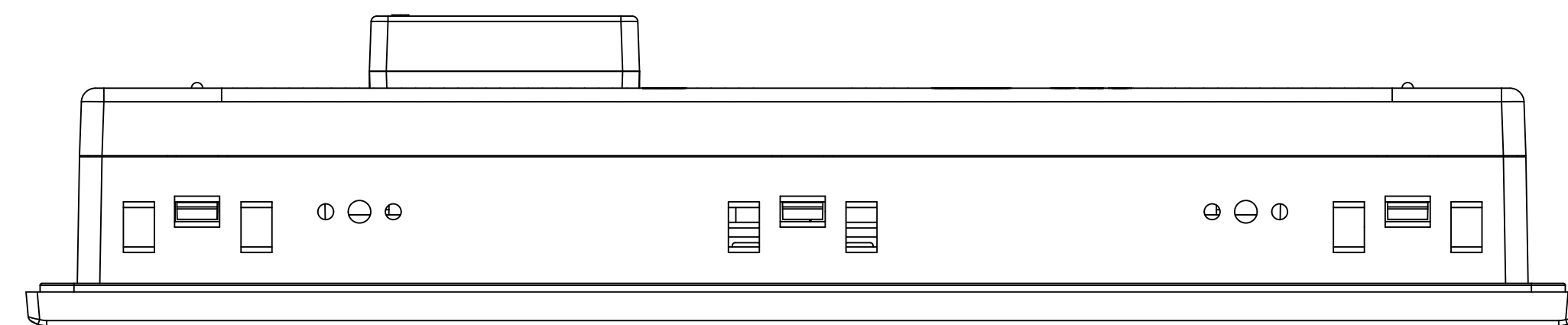
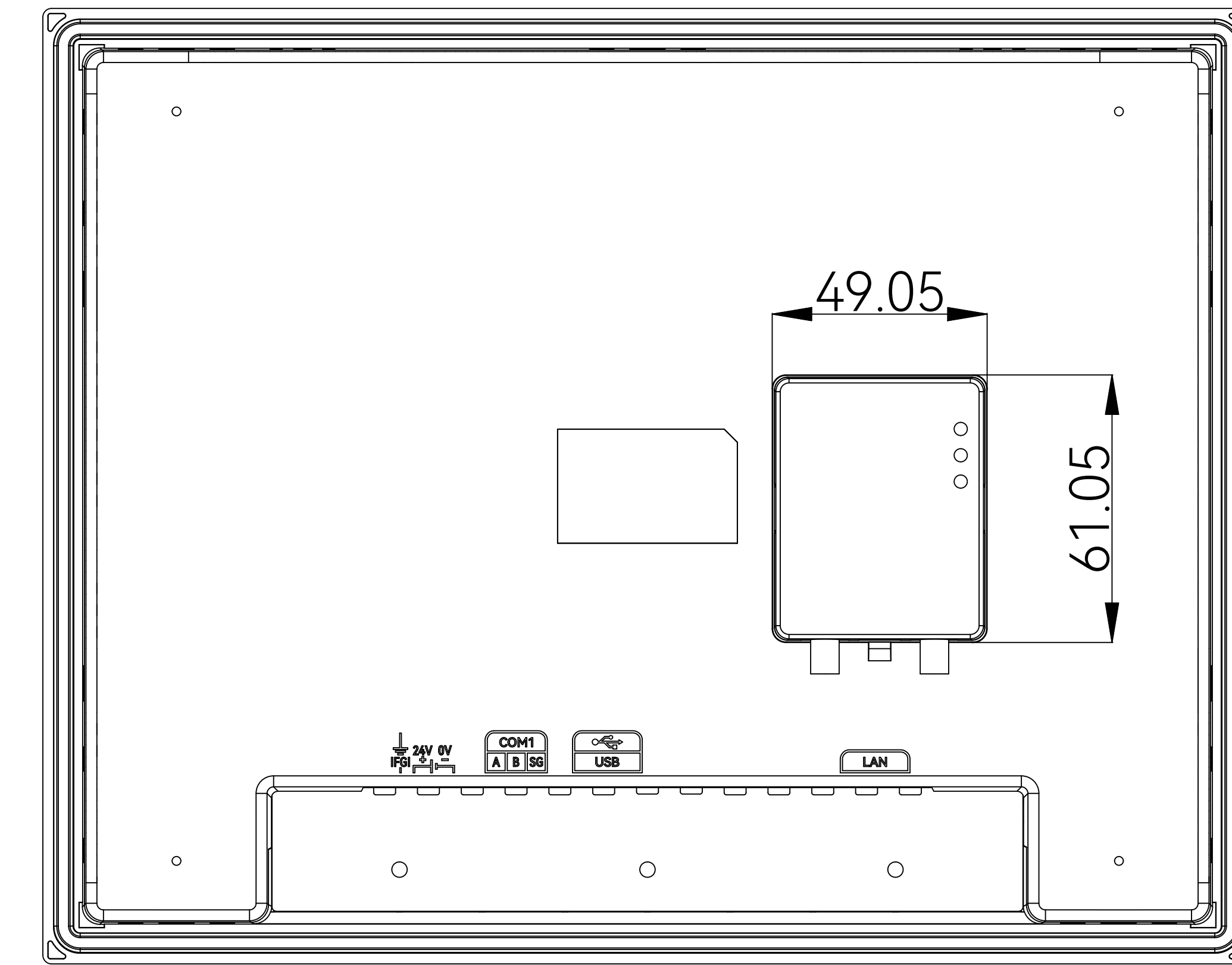
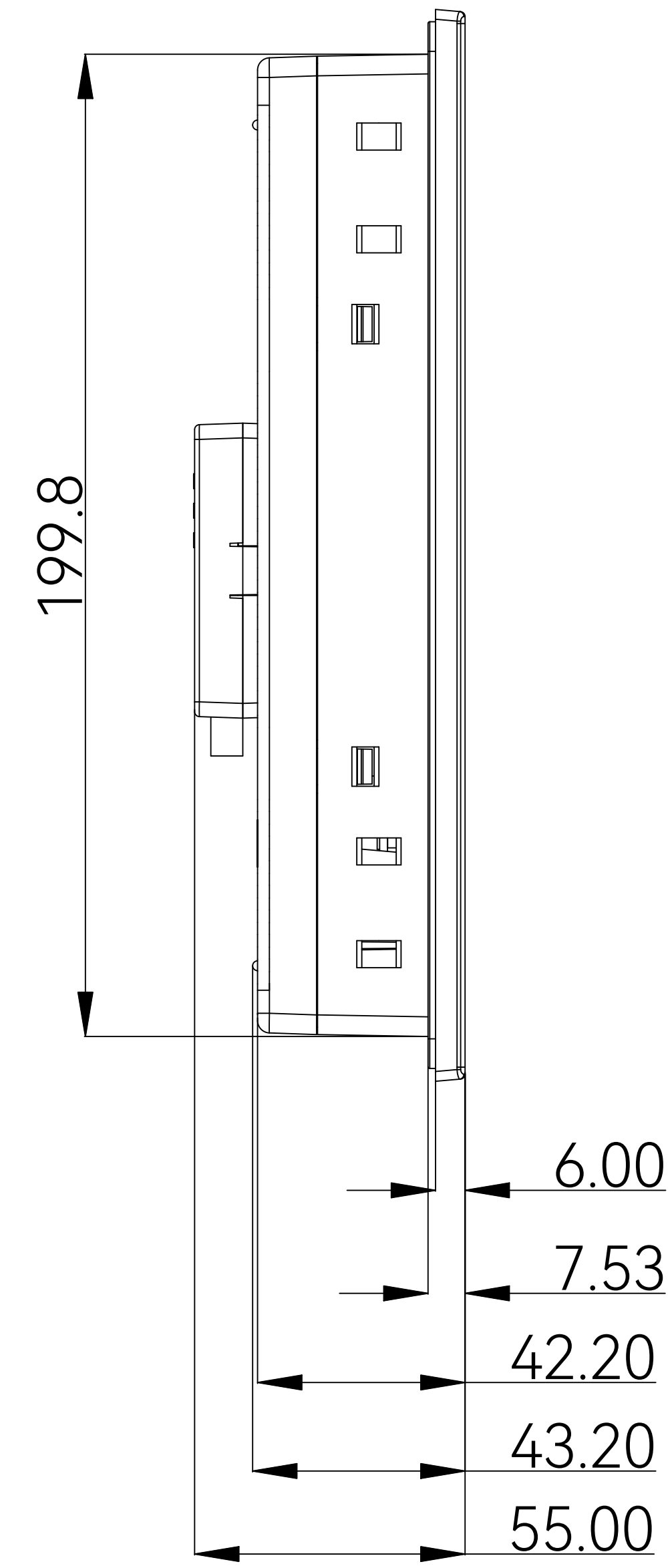
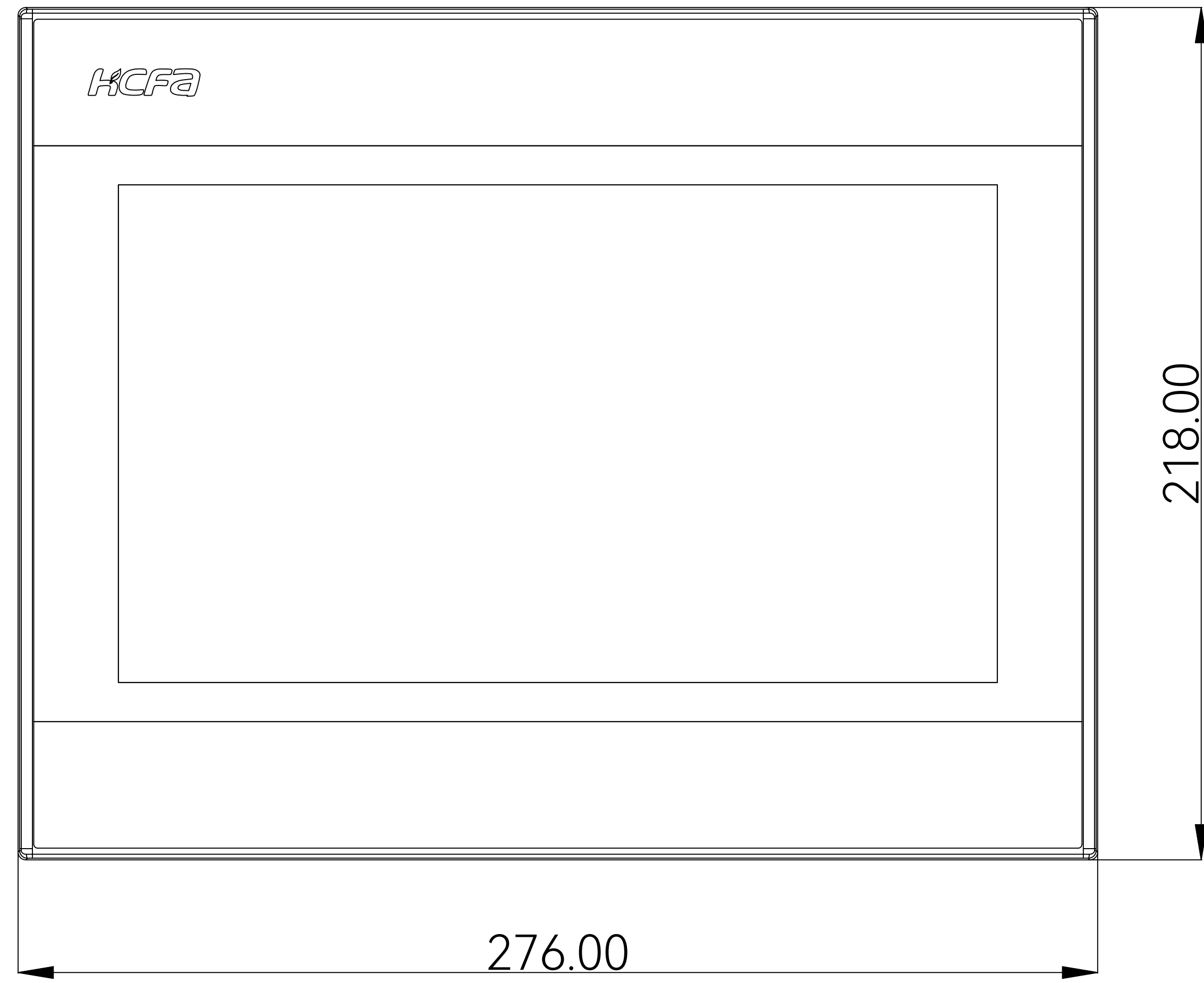
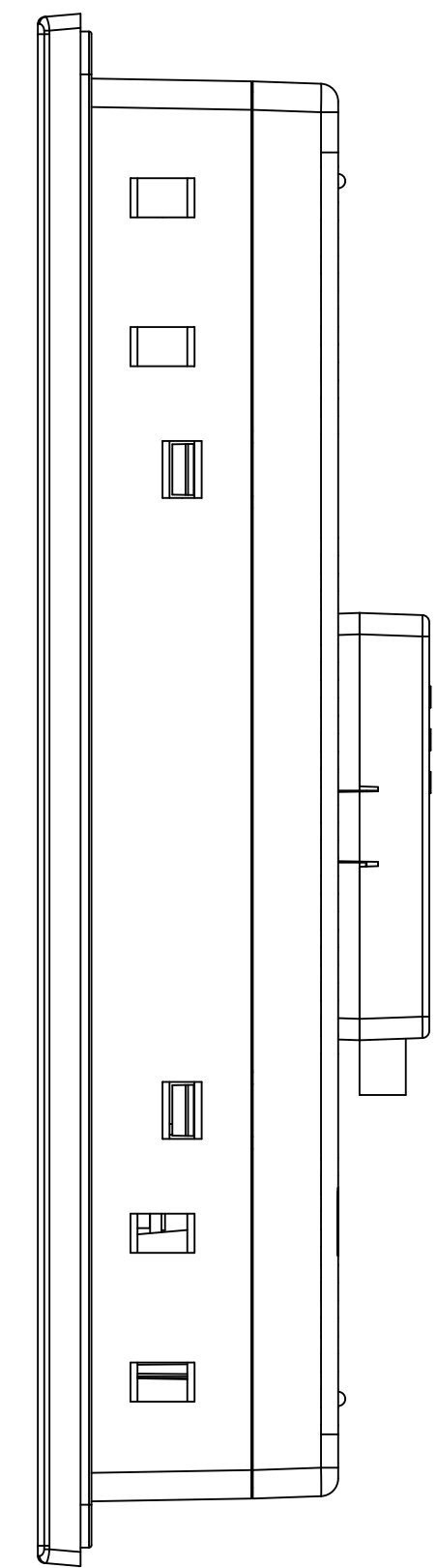
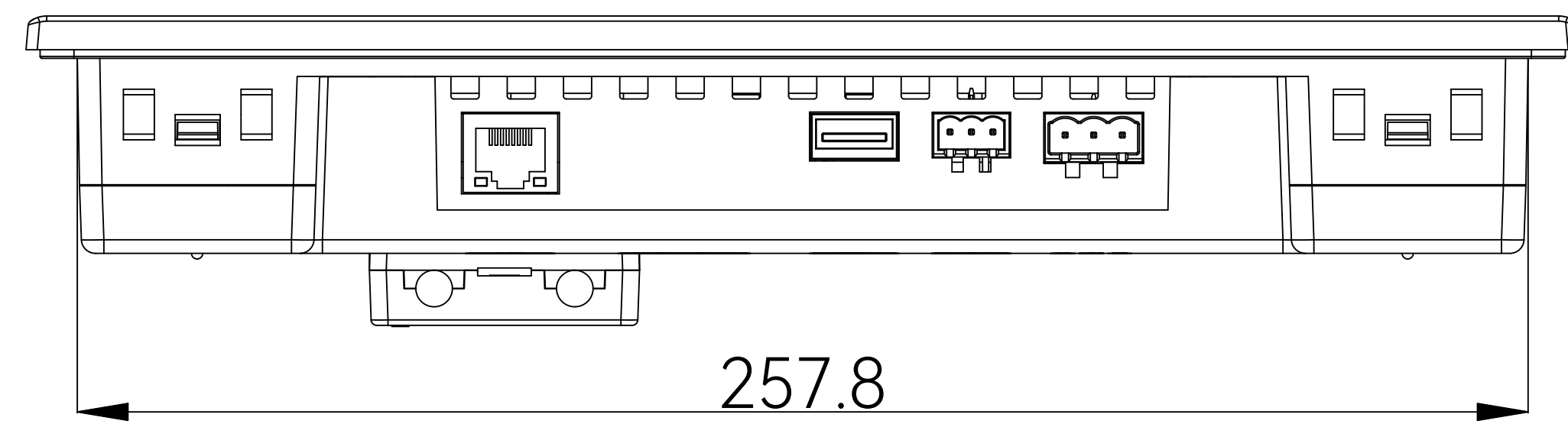

零件材料 RAW MATERIAL	XXXG	NO. 无	比例 SCALE	1:1	日期 DATE	2024/03/13	零件名称 PART NAME	V310S线框六视图
体积 VOL	0 cm ³		单位 UNIT	mm	页码 SHEET	1/1	零件图号 PART CODE	
	设计 DESIGNED BY	画图 DRAWN BY	检查 CHECKED BY	核准 APPROVED BY				
	张志强	张志强	李虎彪	夏鑫岩				
	未注尺寸公差按照国标执行 GB/T 1804-2000-m		浙江禾川科技股份有限公司 ZHEJIANG HECHUAN TECHNOLOGY CO.,LTD. 禾川图纸, 非禾川授权不得转让, 流转和借作他用!					